

ASSEMBLY INSTRUCTIONS

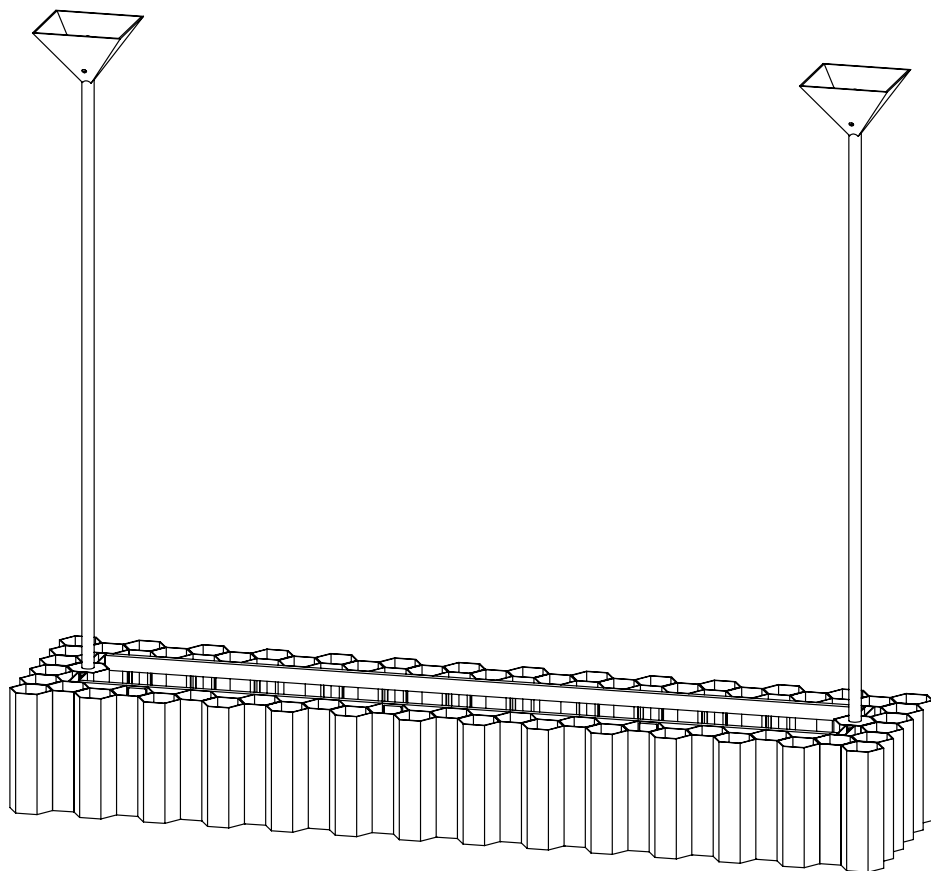

INFO@JULESWABBES.COM
WWW.JULESWABBES.COM

GEDE

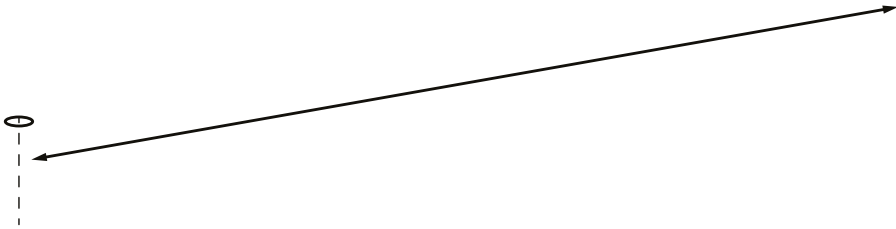
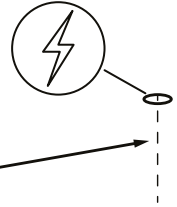
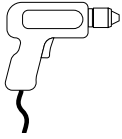

1

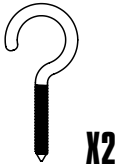

Place the hooks

2

CIRCUIT ELECTRIQUE

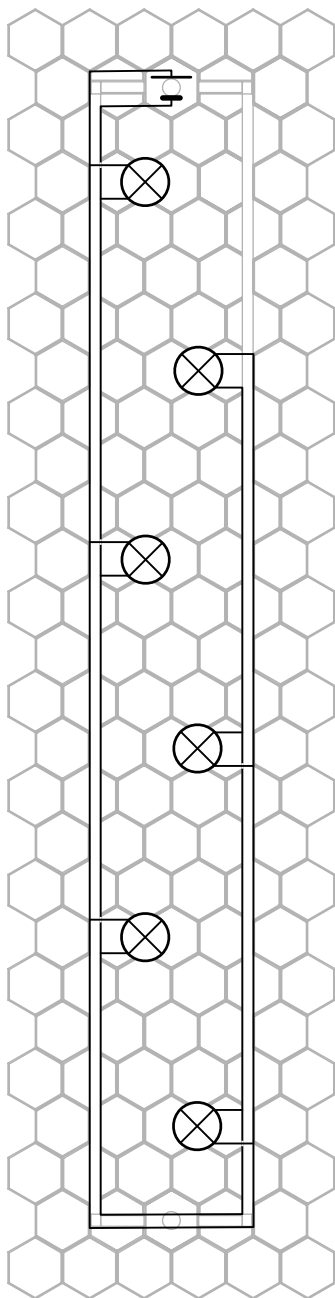

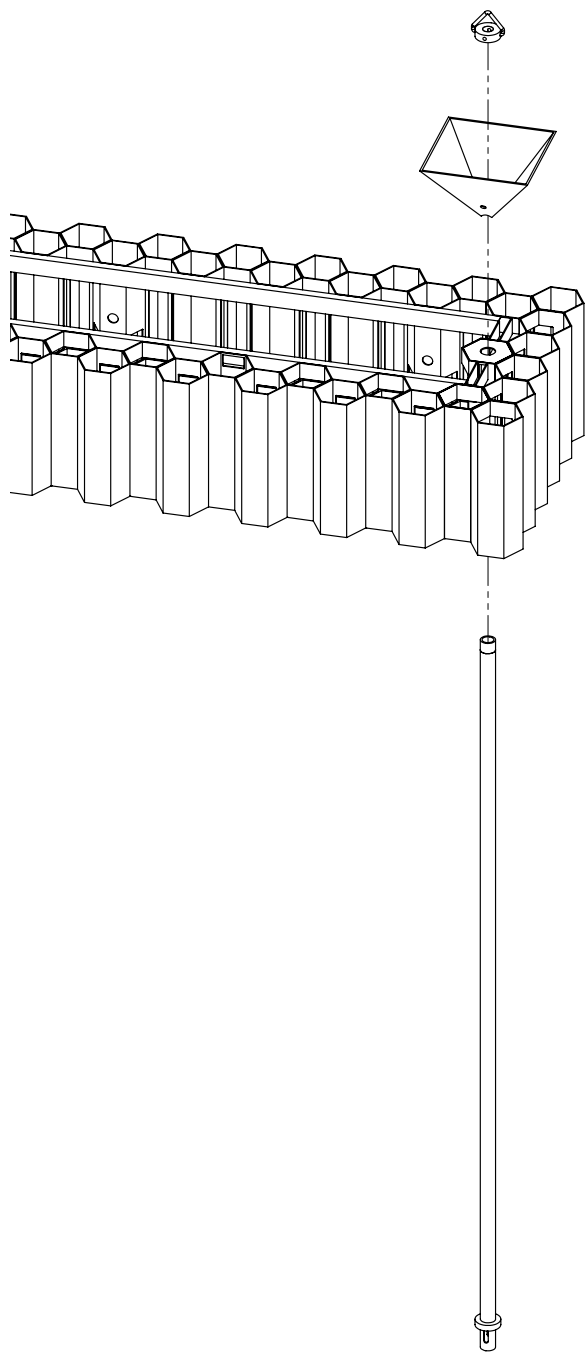

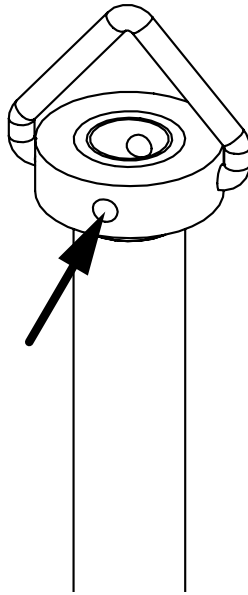
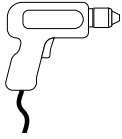

5

Drill a 3mm hole



X2

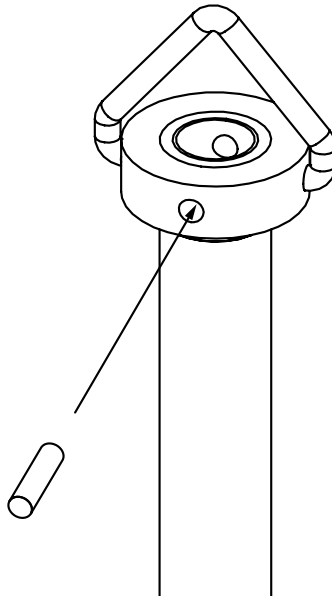

6

Screw through the tube

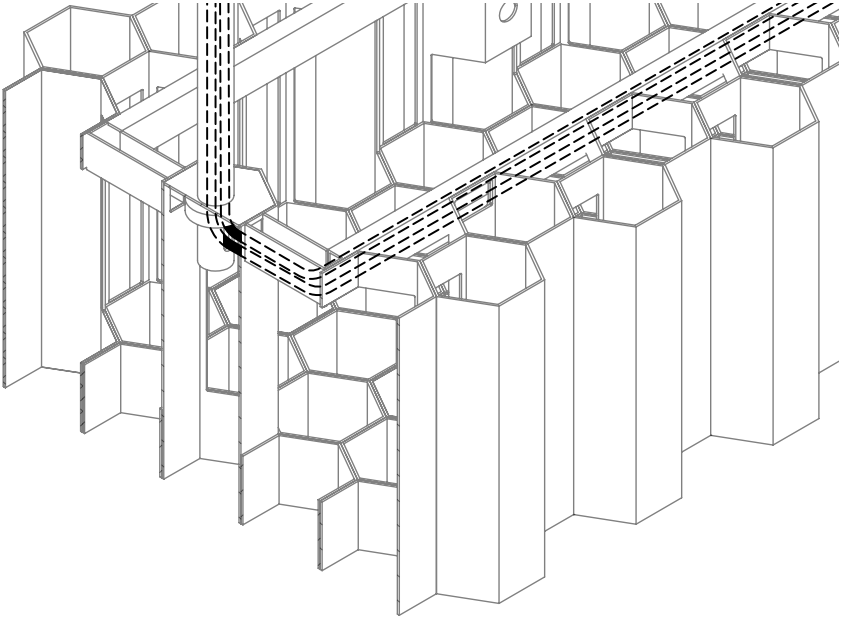

7

Pass carefully the wires through the holes

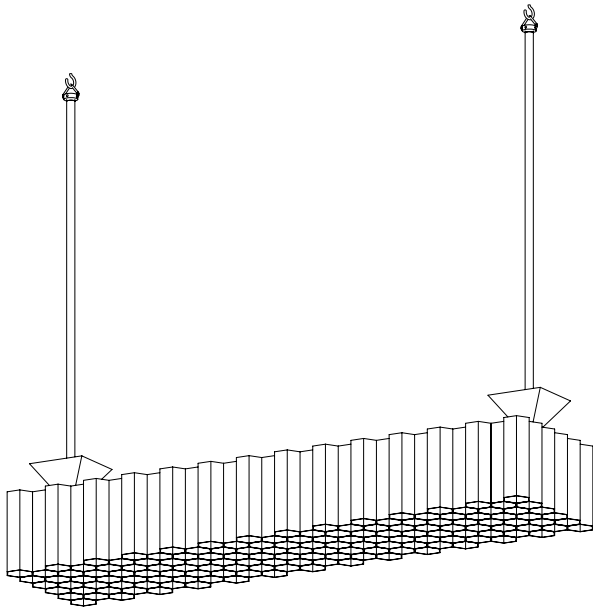

8

Hang the lamp



Connect the lamp

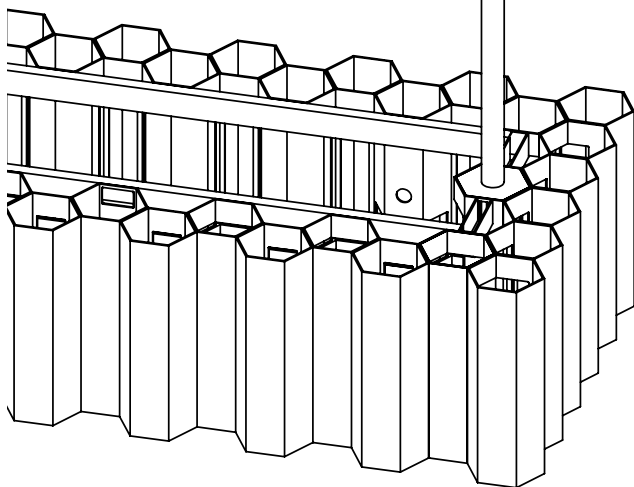
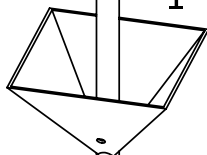

10

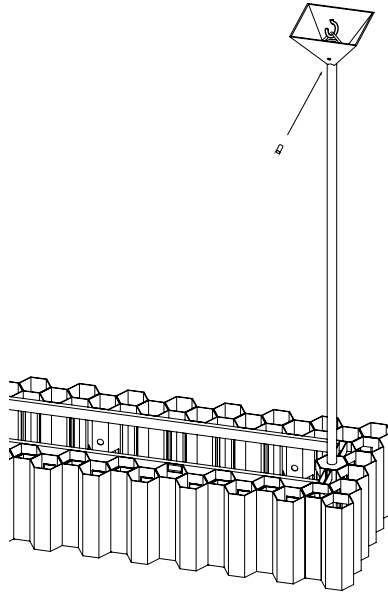

TECHNICAL SPECIFICATIONS

Materials: Brass (Polished or nickel-plated)

Length: 1500 mm - 59.00"

Depth: 240 mm - 9.45"

Height: 130 mm - 5.10"

Weight: 17 kg 37.48 lbs

Light Bulb: E27 Max 60W - E26 40W

Power: AC 220-240V -120V

Material to be placed by a licensed electrician, otherwise we assume no liability or guarantee. The material has been checked and tested by our care before delivery and is fully compliant.