

ASSEMBLY INSTRUCTIONS

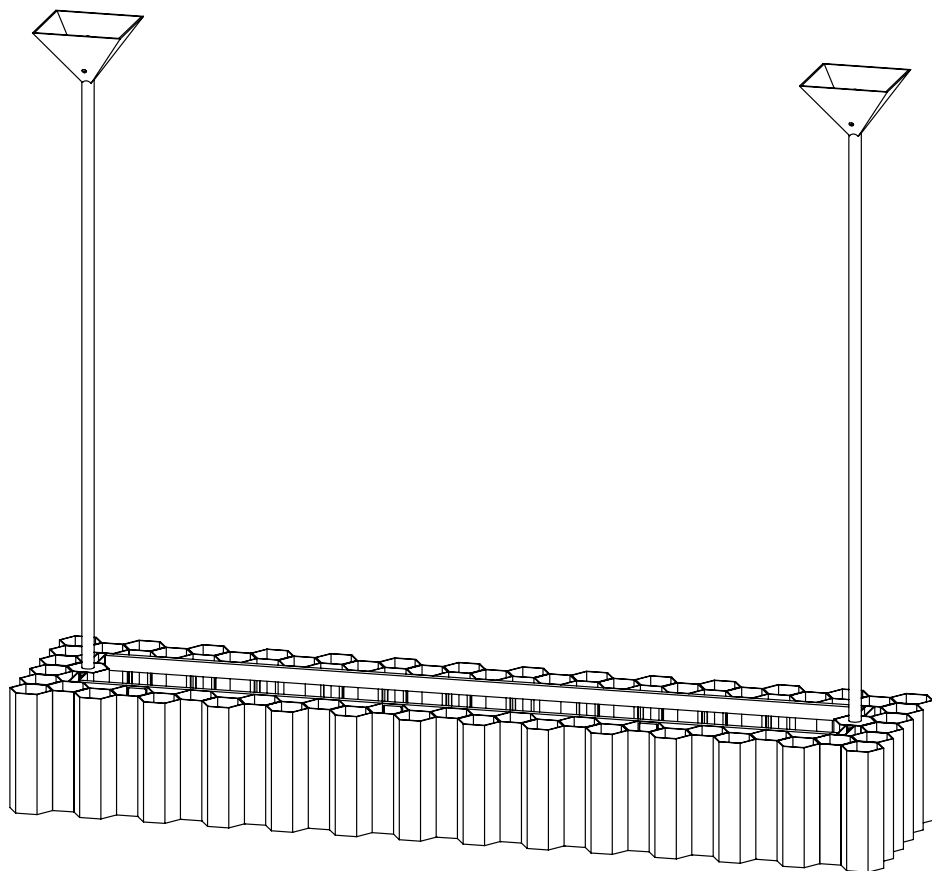

INFO@GENERALDECORATION.COM
WWW.GENERALDECORATION.COM

GEDE

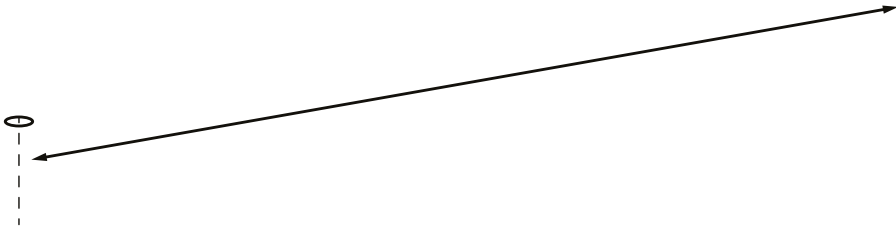
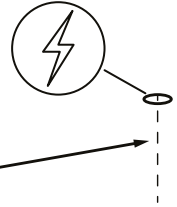
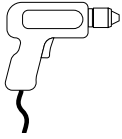

1

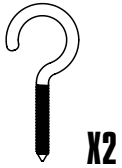

Place the hooks

2

CIRCUIT ELECTRIQUE

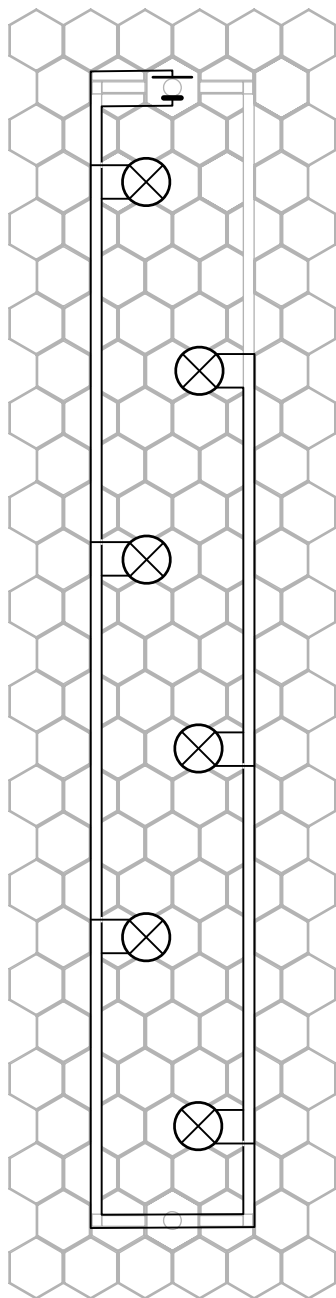

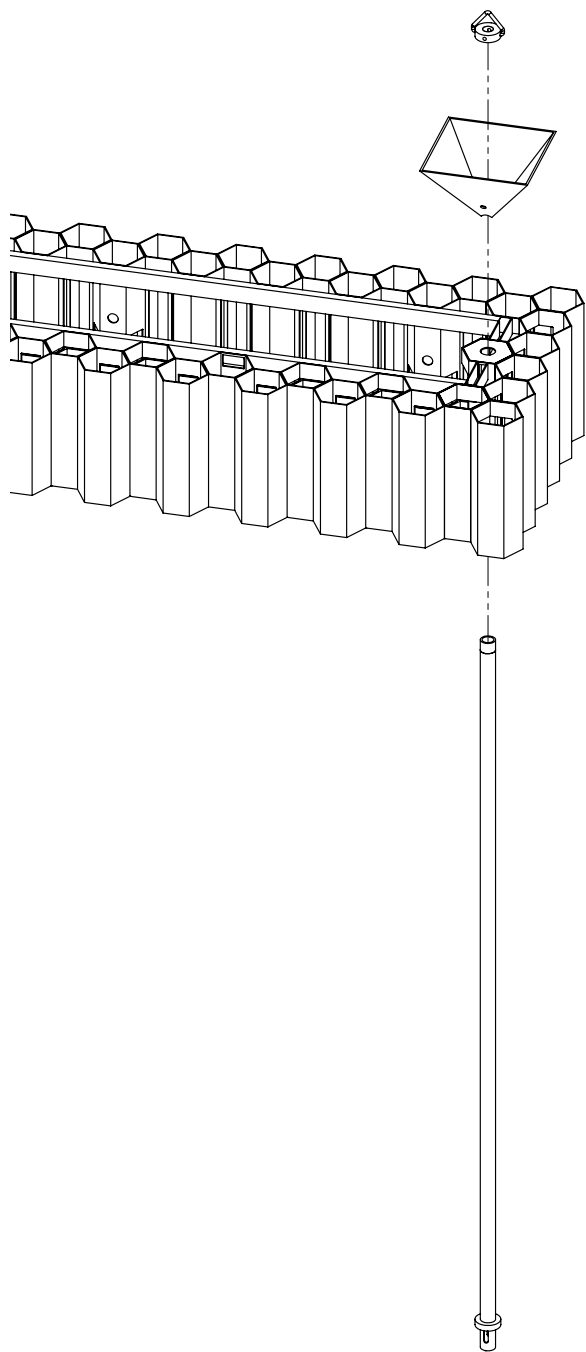

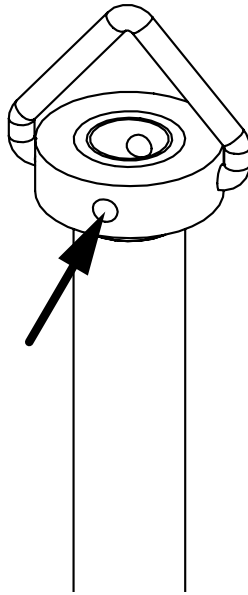
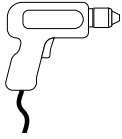

5

Drill a 3mm hole



X2

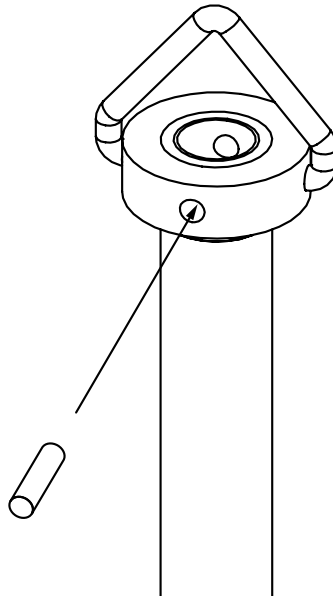

6

Screw through the tube

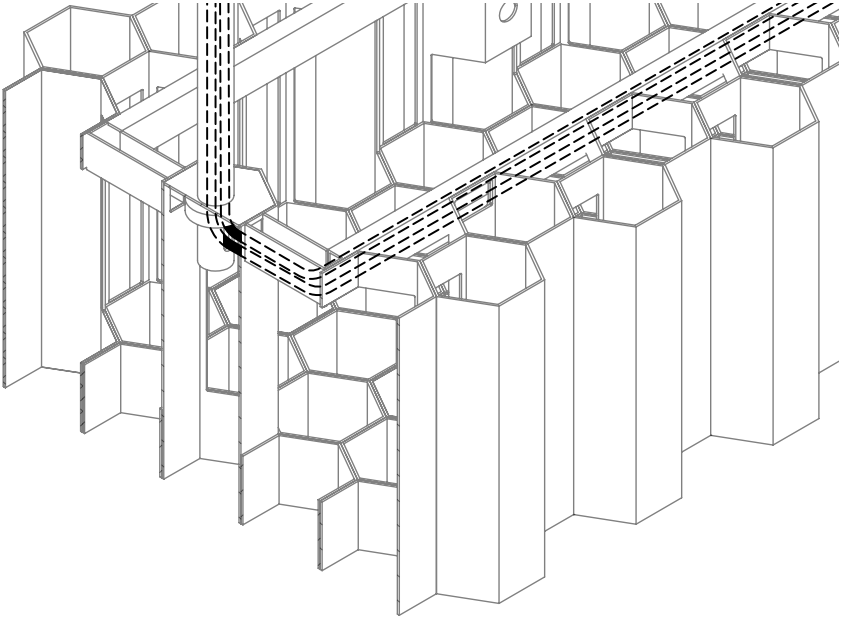

7

Pass carefully the wires through the holes

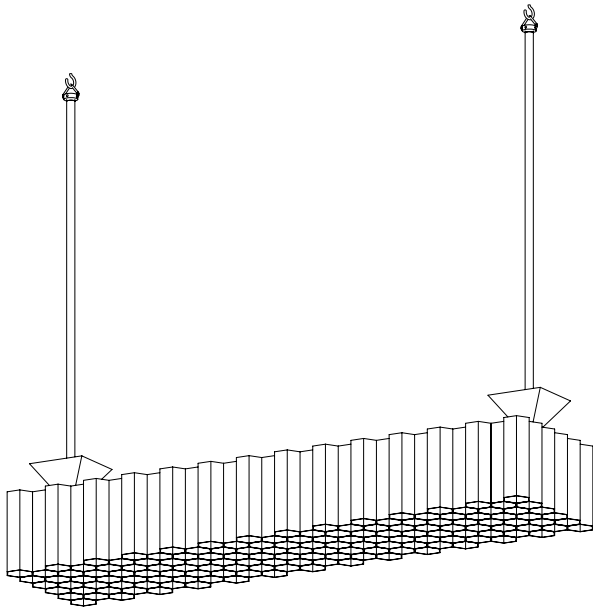

8

Hang the lamp



Connect the lamp

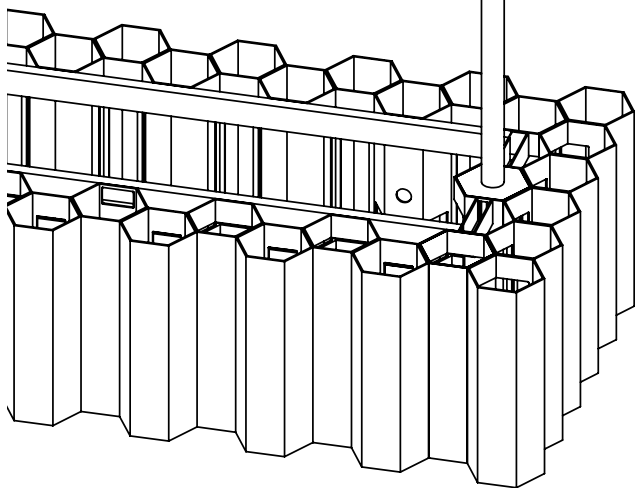
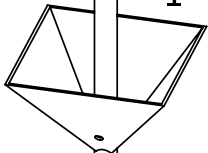
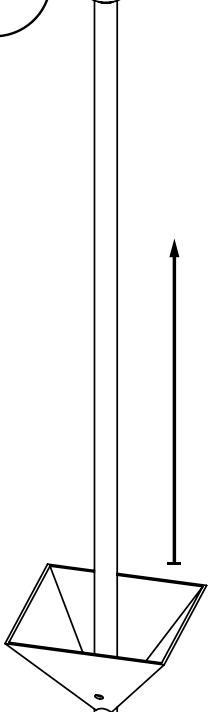

10

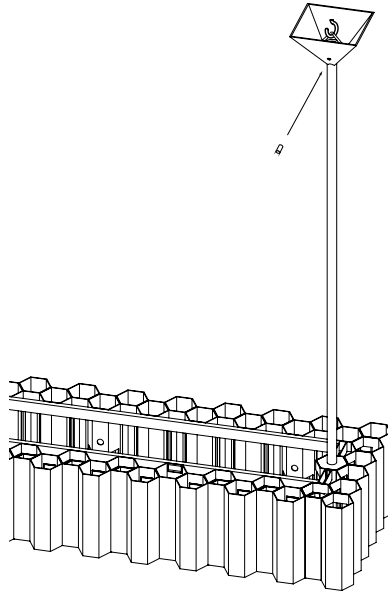

TECHNICAL SPECIFICATIONS

Materials: Polished Brass

Length: 900 mm

Width: 240 mm

Height: 130 mm

Weight: 11.7 kg

Light Bulb: E27 Max 60W (x6)

Power: AC 220-240V

Material to be placed by a licensed electrician, otherwise we assume no liability or guarantee. The material has been checked and tested by our care before delivery and is fully compliant.

GENERALDECORATION

SPRL GENERAL DECORATION 20 ROUTE DE BEAUMONT 1380 LASNE

INSTRUCTIONS D'ASSEMBLAGE

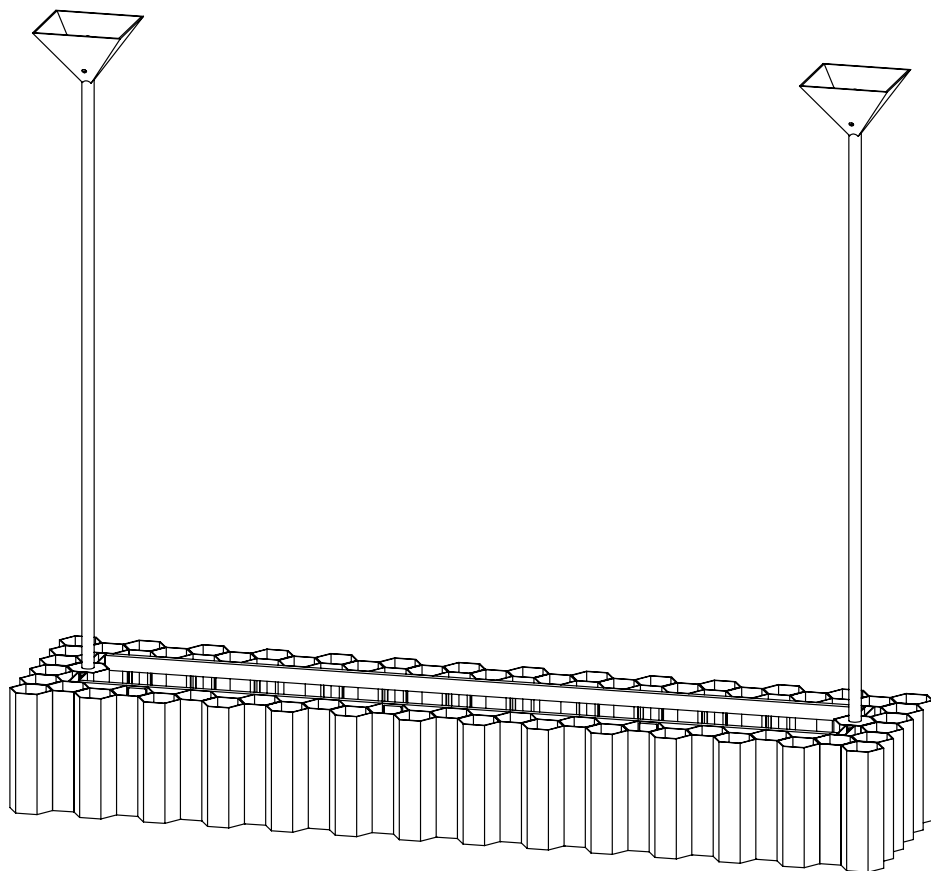

INFO@GENERALDECORATION.COM
WWW.GENERALDECORATION.COM

GEDE

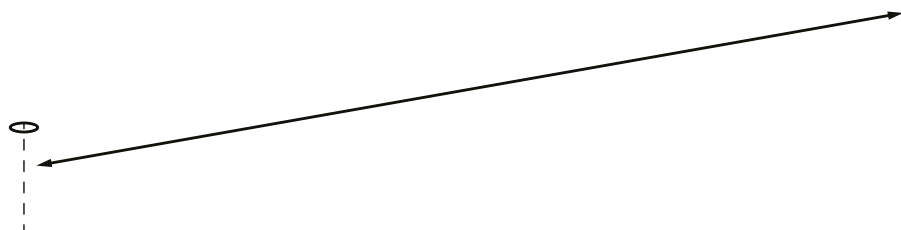

1



X2



Placer les crochets

2

CIRCUIT ELECTRIQUE

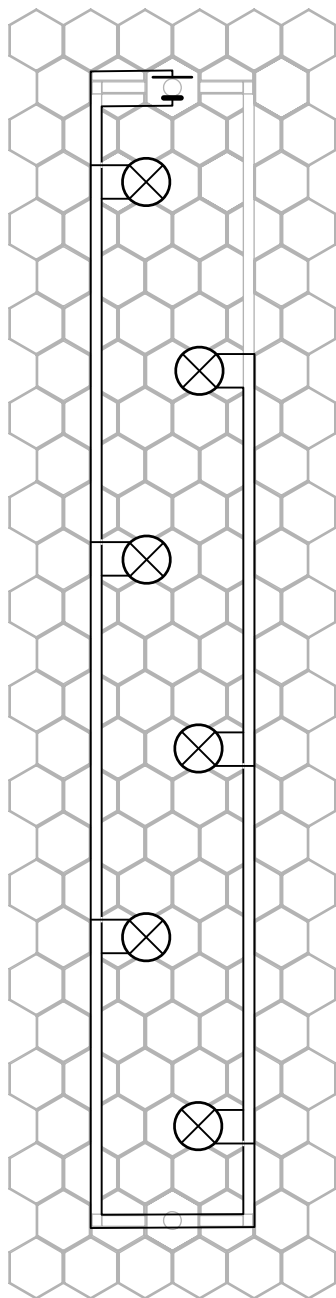

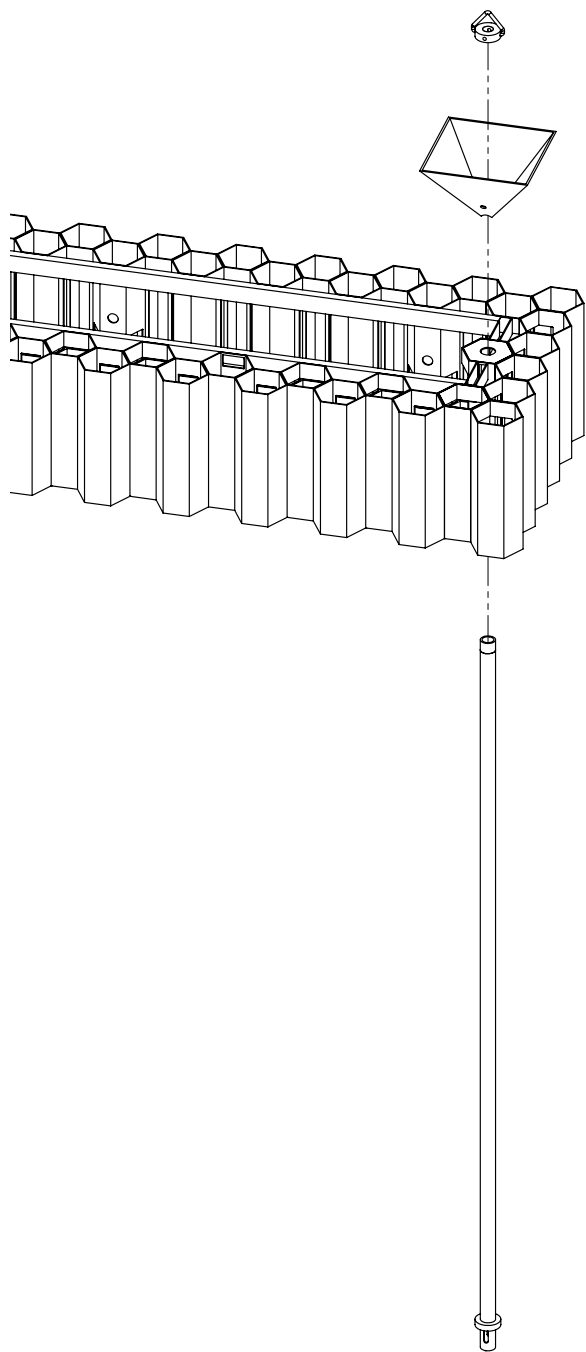

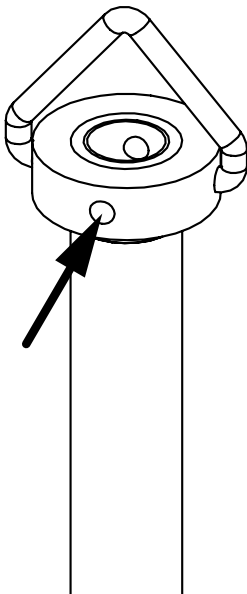
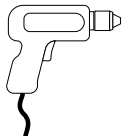

5

Percer un trou de 3mm



X2

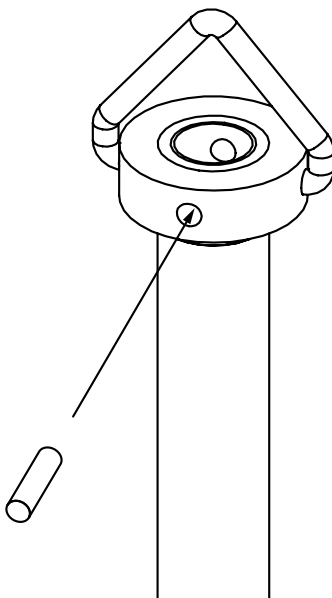

6

Visser à travers le tube

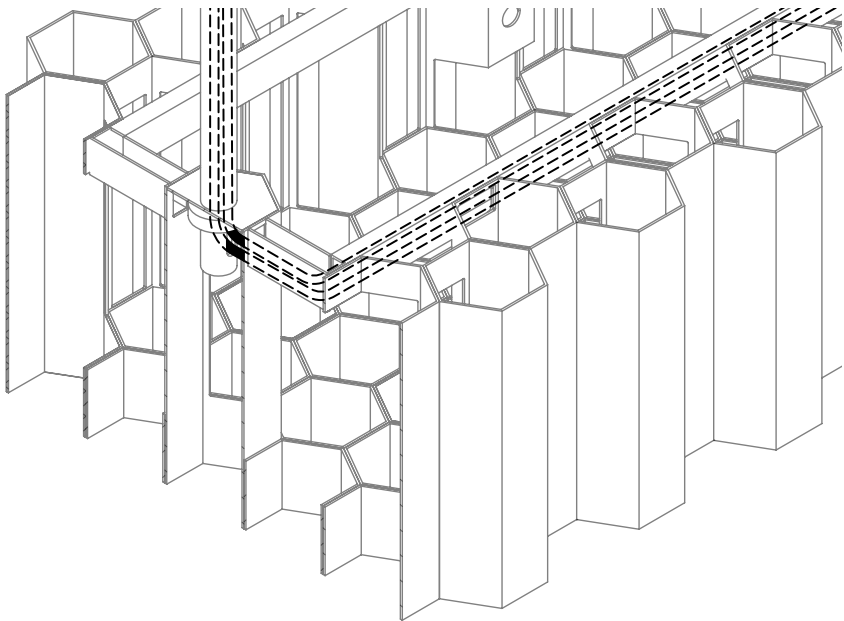

7 Passer soigneusement les fils a travers la fente

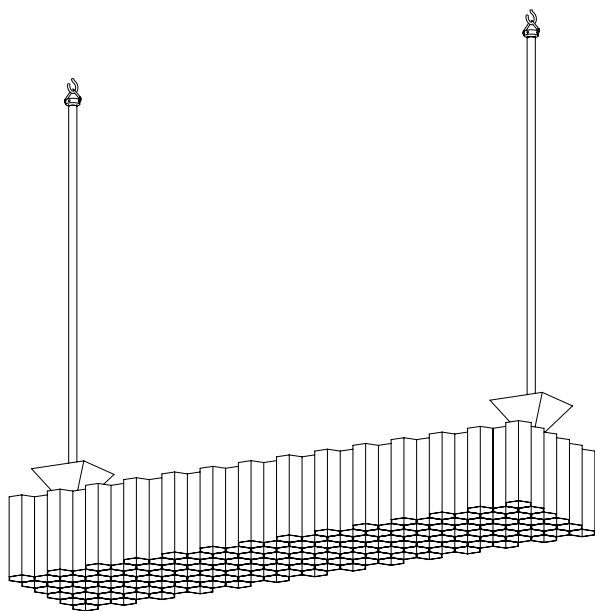

8 Suspendre la lampe



Brancher la lampe

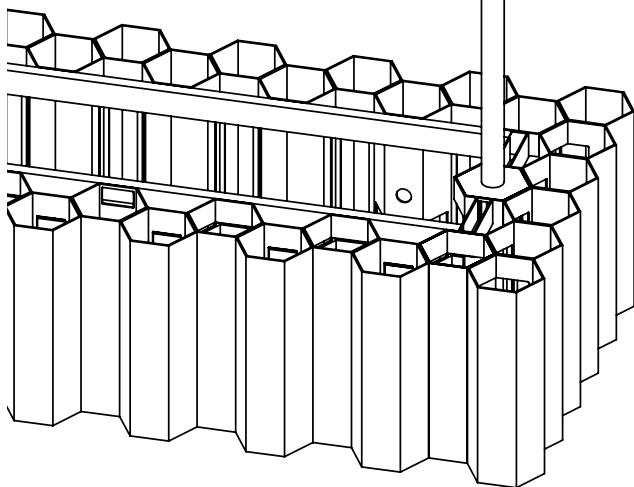
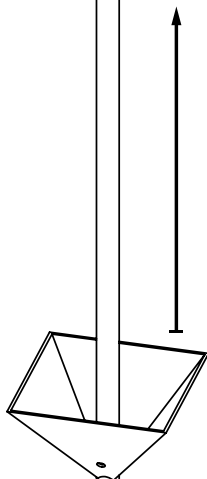

10

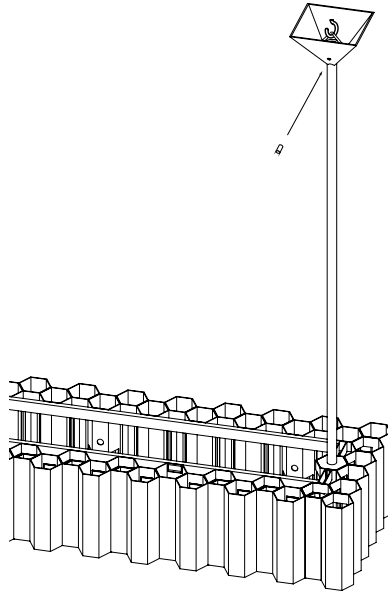

SPÉCIFICATIONS TECHNIQUES

Matériaux: Laiton Poli

Longueur: 900 mm

Largeur: 240 mm

Hauteur: 130 mm

Poids: 11.7 kg

Ampoule: E27 Max 60W (x6)

Alimentation: AC 220-240V

Matériel à placer par un électricien agréé, à défaut nous déclinons toute responsabilité ou garantie. Le matériel a été vérifié et testé par nos soins avant livraison et est totalement conforme.

GENERALDECORATION

SPRL GENERAL DECORATION 20 ROUTE DE BEAUMONT 1380 LASNE